



GAMIA WOOD

ISTRUZIONI DI POSA

ASSEMBLY INSTRUCTIONS

INSTRUCTIONS DE MONTAGE

INSTRUCCIONES PARA LA COLOCACION

MONTAGEANLEITUNG

Gamia Wood

Descrizione

Scala chiocciola modulare in metallo / legno a pianta circolare regolabile in altezza tramite distanziatori metallici interposti tra i gradini.

Nr. gradini e altezze raggiungibili per scale "filo - pavimento"

11 + 1 gradini : 2520 - 2760 mm

12 + 1 gradini : 2730 - 2990 mm

13 + 1 gradini : 2940 - 3220 mm

Gradini

Di faggio massello, spessore 38 mm . Gradini semplici (30°), pianerottolo di arrivo "Testa Tonda", "Testa Dritta" (60°) o quadrato (90°) per fori circolari o quadrati.

Alzate

Standard Min. 210 mm ; Max 230 mm (per alzate 200 ÷ 210 mm; 230 ÷ 240 mm si possono adattare le colonne in fase di posa).

Ringhiera

A colonne in tubo di metallo Ø 22 mm (luce max tra le colonne < 100 mm). Corrimano di materiale plastico flessibile (ht. corrimano = 1 m).

Finitura e colori

Parti di legno: tonalizzate con vernice all'acqua (Naturale 12)

Parti di metallo: verniciate a forno con polveri epossidiche (Nero goffrato).

Componenti in plastica, gomma e viteria: nero.

Kit

a) Confezione nr. 11 gradini semplici completi Ø 1200, 1400, 1600 mm

b) Confezione pianerottolo di arrivo completo Ø 1250, 1450, 1650 mm

c) Confezione gradino semplice aggiuntivo Ø 1200, 1400, 1600 mm

d) Confezione balaustra 1 m

e) Confezione "traversino / alzata" per nr.11 gradini

Description

Modular spiral staircase in metal / wood, with round section and adjustable spacers

Number of steps and "floor-to-floor" height

11 + 1 steps : 2520-2760 mm (8 3 1/4" - 9 0")

12 + 1 steps : 2730-2990 mm (8 11 1/2" - 9 9 3/4")

13 + 1 steps : 2940-3220 mm (9 7 3/4" - 10 6 3/4")

Steps

Of solid beech wood, thickness 38 mm (1 1/2").

Step angle 30°, round or triangular landing angle 60°, square landing angle 90° for round or square opening

Risers

Standard Min 210 mm (8 1/4"); Max 230 mm (9") (for risers 200 ÷ 210 mm (7 7/8" ÷ 8 1/4"); 230 ÷ 240 mm (9" ÷ 9 1/2") it is possible to cut the balusters during the assembly)

Railing

With metal steel tubing balusters Ø 22 mm (7/8") (clear space among the balusters < 100 mm, 4"). Flexible plastic handrail (handrail height = 1000 mm, 39 3/8")

Finishes and colours

Wood: polished with water varnish (Natural 12). Metal: plastic coated (Embossed black).

Plastic componentes, rubber matting and screws: black.

Kit

a) Packing with 11 complete simple steps Ø 1200, 1400, 1600 mm (47 1/4", 55 1/8", 63")

b) Packing with complete landing platform Ø 1250, 1450, 1650 mm (49 1/4", 57 1/8", 65")

c) Packing with one simple extra step Ø 1200, 1400, 1600 mm (47 1/4", 55 1/8", 63")

d) Packing balustrade 1000 mm (39 3/8") long section (handrail apart)

e) Packing "safety-riser" for 11 steps

Gamia Wood

Description

Escalier hélicoïdal modulaire en métal / bois à plan circulaire réglable en hauteur avec entretoises en métal entre les marches.

N. marches et hauteurs possibles au "niveau du sol"

11 + 1 marches : 2520 - 2760 mm

12 + 1 marches : 2730 - 2990 mm

13 + 1 marches : 2940 - 3220 mm

Marches

En hêtre massif, épaisseur 38 mm . Angle marches 30 °, angle palier arrondi, droit 60° ou carré 90° pour trémies arrondies ou carrées.

Hauteur de marche

Standard Min. 210 mm; Max 230 mm (pour hauteurs 200 ÷ 210 mm; 230 ÷ 240 mm balustres adaptables pendant la pose).

Rampe

Avec balustres en tube de metal Ø 22 mm (distance entre les balustres < 100 mm). Main courante en materiel plastique flexible (hauteur main courante = 1 m).

Finitions et couleurs

Parties en bois : teintées avec vernis à l'eau (Naturel 12) - Parties en métal : traitées en époxy (Noir gaufré).

Parties en plastique, tapis et visserie: noir.

Kit

a) Carton n. 11 marches simples complètes Ø 1200, 1400, 1600 mm

b) Carton palier d'arrivée complet Ø 1250, 1450, 1650 mm

c) Carton marche simple supplémentaire Ø 1200, 1400, 1600 mm

d) Carton garde-corps 1 m

e) Carton " bras / hauteur de marche " pour n. 11 marches

Descripción

Escalera de caracol modular de metal / madera con planta circular con altura regulable mediante los distanciadores de metal entre los peldaños.

Nº Peldaños y alturas totales posibles a "nivel del piso"

11 + 1 peldaños : 2520 - 2760 mm

12 + 1 peldaños : 2730 - 2990 mm

13 + 1 peldaños : 2940 - 3220 mm

Peldaños

De haya maciza espesor 38 mm.

Ángulo de los peldaños simples 30°, ángulo de rellano redondo / recto 60°, cuadrado 90° para orificios circulares o cuadrados.

Contrahuellas

Estándar Mín. 210 mm; Max 230 mm (para contrahuellas 200 ÷ 210 mm; 230 ÷ 240 mm los barrotes se pueden adaptar en fase de montaje).

Baranda

De barrotes en tubo de metal Ø 22 mm (luz entre los barrotes < 100 mm). Pasamanos de material plástico flexible (altura pasamanos = 1 m).

Acabado y colores

Piezas de madera : tintadas a base de agua (Natural 12) Piezas de metal : barnizadas al horno con polvos epoxídicos (Negro gofrado). Elementos de plástico, goma y tornillos : negros.

Kit

a) Confección 11 peldaños simples Ø 1200, 1400, 1600 mm

b) Confección rellano de desembarque completo Ø 1250, 1450, 1650 mm

c) Confección peldaño simple extra Ø 1200, 1400, 1600 mm

d) Confección balaustra 1 m

e) Confección "barra / contrahuella" para 11 peldaños

Gamia Wood

Beschreibung

Modulare Spindeltruppe aus Metall / Holz mit rundem Grundriss regulierbar mit Abstandstücken aus Metall

Anzahl der Stufen und Gesamthöhe der Treppe

11 + 1 Stufen : 2520 - 2760 mm

12 + 1 Stufen : 2730 - 2990 mm

13 + 1 Stufen : 2940 - 3220 mm

Stufen

Aus Massiver Buche mit einer Stärke von 38 mm Stufen (Winkel 30°), abgerundetes oder gerades Podest (Winkel 60°), quadratisches Podest Winkel 90°).

Steigungen

Standard Min. 210 mm; Max 230 mm (für Steigungen 200 ÷ 210 mm; 230 ÷ 240 mm verstellbar während der Montage).

Geländer

Mit Metallstäben \varnothing 22 mm (Distanz zwischen der Stäben max < 100 mm). Modulierbarer Handlauf aus Plastik (Höhe Handlauf = 1 m)

Oberflächenausführung und Farben

Holzteile: mit wasserlöslicher Beize versehen (Natur 12)

Metallteile: Epoxyd-Einbrennlackierung (Schwarz gaufriert). Elemente aus Plastik, Auflagen und Schrauben: schwarz.

Kit

a) Verpackungseinheit mit 11 kompletten Stufen \varnothing 1200, 1400, 1600 mm

b) Verpackungseinheit mit komplettem Podest \varnothing 1250, 1450, 1650 mm

c) Verpackungseinheit mit zusätzlicher Stufe \varnothing 1200, 1400, 1600 mm

d) Verpackungseinheit Balustrade 1 m **e)** Verpackungseinheit „Sicherheit der Steigung“ für 11 Stufen (Kinder-Sicherung)

Gamia Wood

Verificare le dimensioni del vano scala prima di procedere con la posa. Controllare che, nelle zone dove verranno effettuati i fissaggi della scala, non vi siano tubature o cavi elettrici, onde evitarne il danneggiamento.

After assemble the stair, check well all staircase well dimension. Before starting to install the stair, make sure that in the installation area there are no pipes or power cables to prevent damaging these.

Vérifier les dimensions de la cage avant de procéder à la pose. Vérifier que les fixations de l'escalier ne tombent pas sur des conduites ou des câbles électriques

Verificar las dimensiones del espacio donde irá la escalera antes de iniciar el montaje Controlar que, en las zonas donde se efectuarán las fijaciones de la escalera, no haya tubos o cables eléctricos, para evitar daños.

Vor Beginn der Treppemontage messen Sie das Treppenhaus nach. Um Beschädigungen zu vermeiden, überprüfen Sie vor Beginn der Montage, daß sich in dem Bereich, in dem die Treppe befestigt wird, keine Rohrleitungen oder elektrische Kabel befinden.

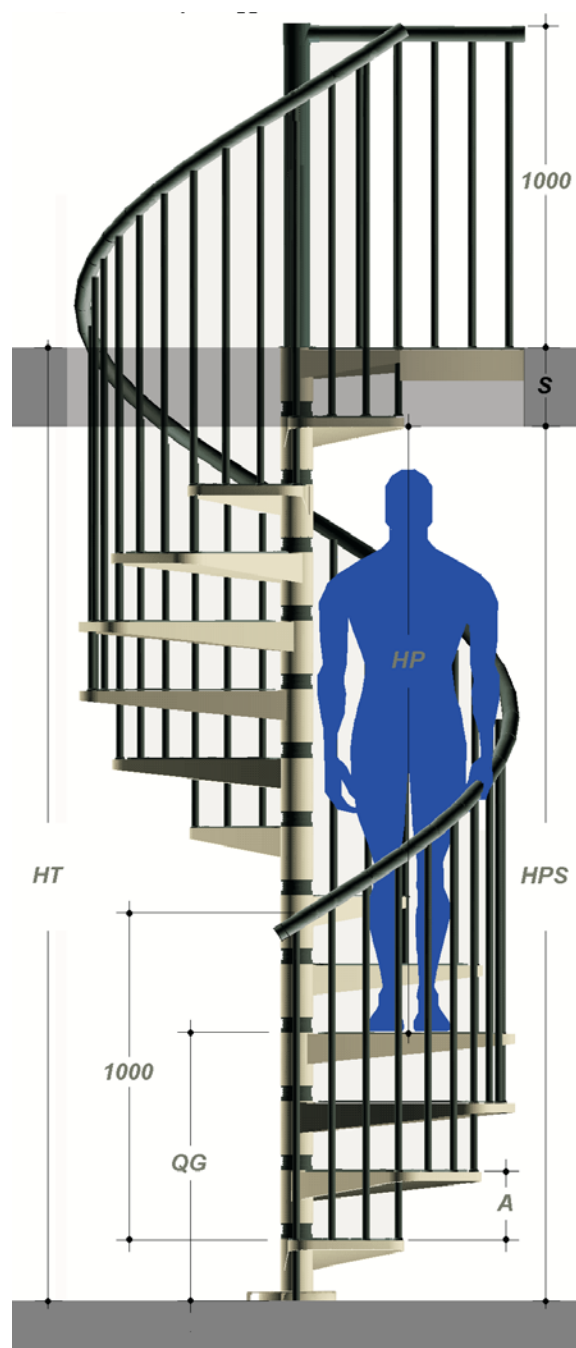

HT - Altezza totale da pavimento a pavimento (HPS+S)
HPS - Altezza da pavimento inferiore a soffitto (HT-S)
S - Spessore solaio (HT-HPS)
A - Altezza alzata (HT/Nr. alzate)

HT - Hauteur totale sol fini à sol fini (HPS+S)
HPS - Hauteur sous plafond (HT-S)
S - Epaisseur de la dalle (HT-HPS)
A - Hauteur de la marche (Hauteur totale : n.hauteurs de marches)

HT - Altura total de suelo a suelo (HPS+S)
HPS - Altura de suelo inferior a techo (HT-S)
S - Espesor de la losa o piso (HT-HPS)
A - Altura contrahuella (HT / Nr. contrahuellas)

HT - Floor-to-floor height (HPS+S)
HPS - Floor-to-ceiling height (HT-S)
S - Floor thickness (HT-HPS)
A - Riser height (HT : riser number)

HT - Höhe Oberkante Fertigfußboden / Oberkante Fertigfußboden (HPS+S) "93Stockwerkshöhe"93
HPS - Höhe Oberkante Fertigfußboden / Decke (HT-S)
S - Deckenstärke (HT-HPS)
A - Steigung (HT : Anzahl der Steigungen)

Gamia Wood

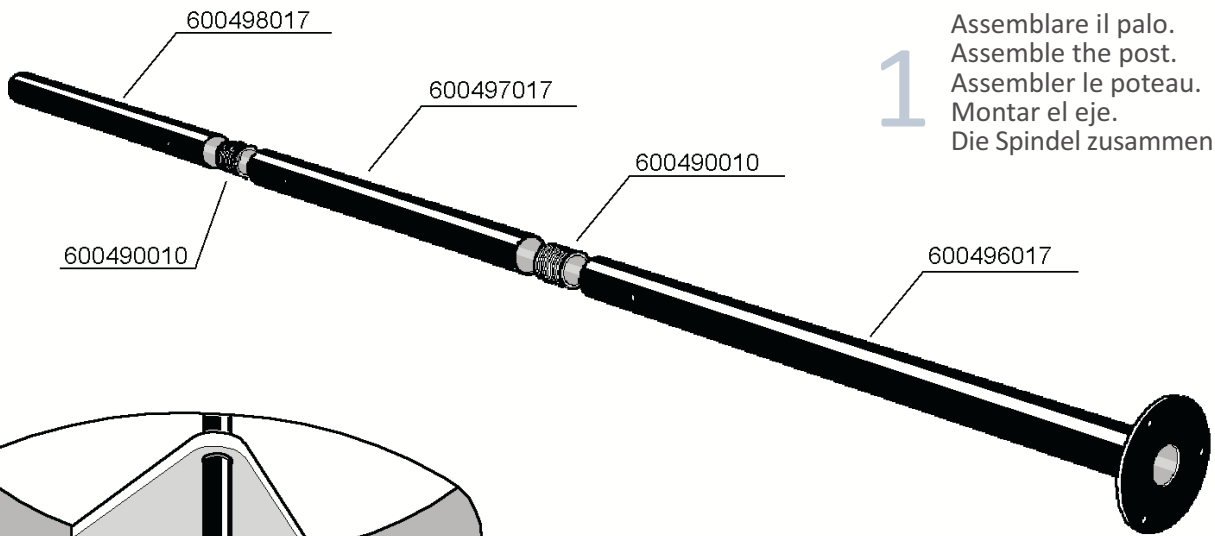

1

Assemblare il palo.
Assemble the post.
Assembler le poteau.
Montar el eje.
Die Spindel zusammenbauen.

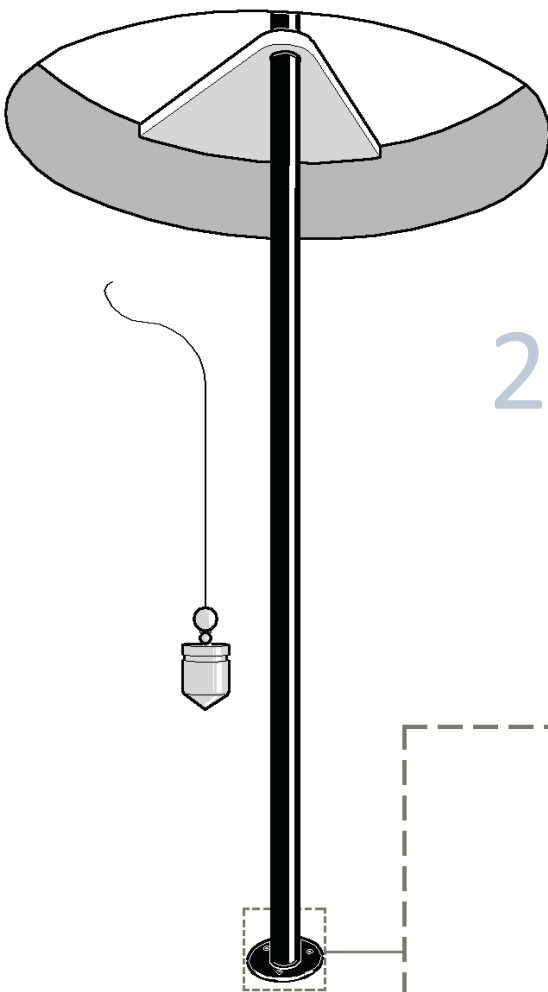

Posizionare il palo in riferimento al foro, disponendo il gradino di arrivo sul lato di uscita della scala.

Position the post with reference to the opening, arranging the landing step on the exit side of the stair

2

Positionner le poteau dans l'axe exact de la trémie, en plaçant la marche d'arrivée sur le côté de sortie de l'escalier.

Colocar el eje con referencia al orificio, poniendo el rellano de desembarque sobre el lado de salida de la escalera.

Die Spindel vollkommen ausrichten und dabei das Austrittspodest als Anhaltspunkt benutzen.

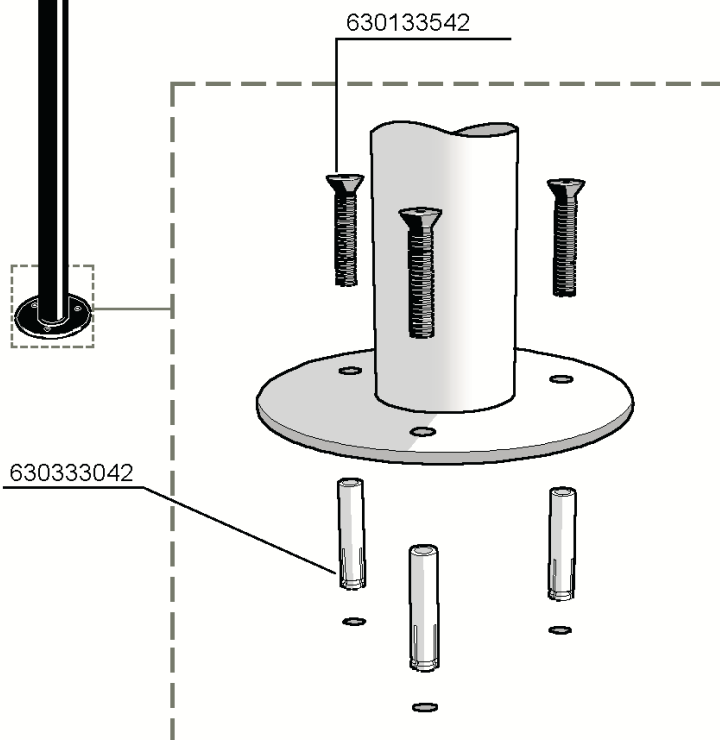

Gamia Wood

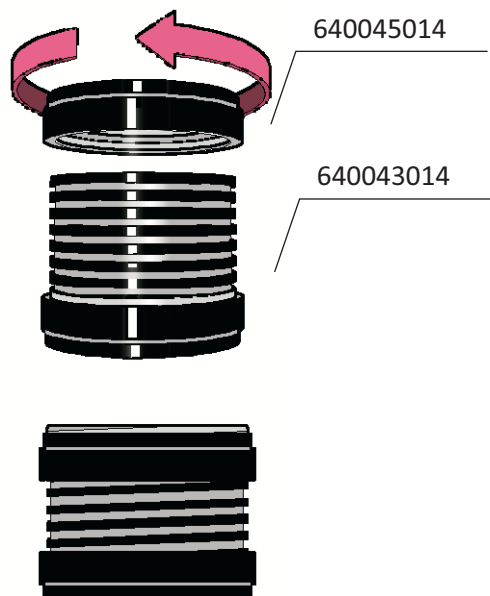

Alzata 160 mm
Riser – 160 mm (6 1/4")
Hauteur de marche – 160 mm
Contrahuella – 160 mm
Steigung – 160 mm

Regolare i distanziali in plastica avvitando la ghiera filettata, lasciando tra le due battute una distanza pari a "Alzata - 10 mm"

Regulate the plastic spacers adjusting the ring nut, leaving between the two ledges a distance equivalent to:
Riser – 160 mm (6 1/4").

3

Régler les entretoises en plastique en serrant la bague filetée et en gardant une distance égale à "Hauteur de marche - 160 mm".

Regular los distanciadores de plástico enroscando la virola roscada, dejando entre los dos topes una distancia equivalente a "Contrahuella - 160 mm"

Die Distanzstücke zusammenbauen und den Gewindeflansch auf die erforderlich Auftrittshöhe einstellen und lassen Sie zwischen eine Höhe von „Steigung - 160 mm“ feststellen.

Inserire gli elementi nel palo iniziando dal copripiastra in basso, proseguendo con distanziali e gradini, sino all'inserimento del gradino di arrivo.

Insert the elements in the post beginning from the plate cover, going on with spacers and steps and finishing with the landing.

4

Empiler tour à tour les éléments (entretoises et marches) dans le poteau sans oublier au départ le couvreembase et terminer avec l'installation de la marche d'arrivée.

Insertar los elementos en el eje comenzando por la brida del eje, continuando con los distanciadores y los peldaños, hasta insertar el rellano de desembarque.

Alle Elemente in die Spindel einsetzen:
Plattenabdeckung, Distanzstücken, Stufen und Austrittsstufe.

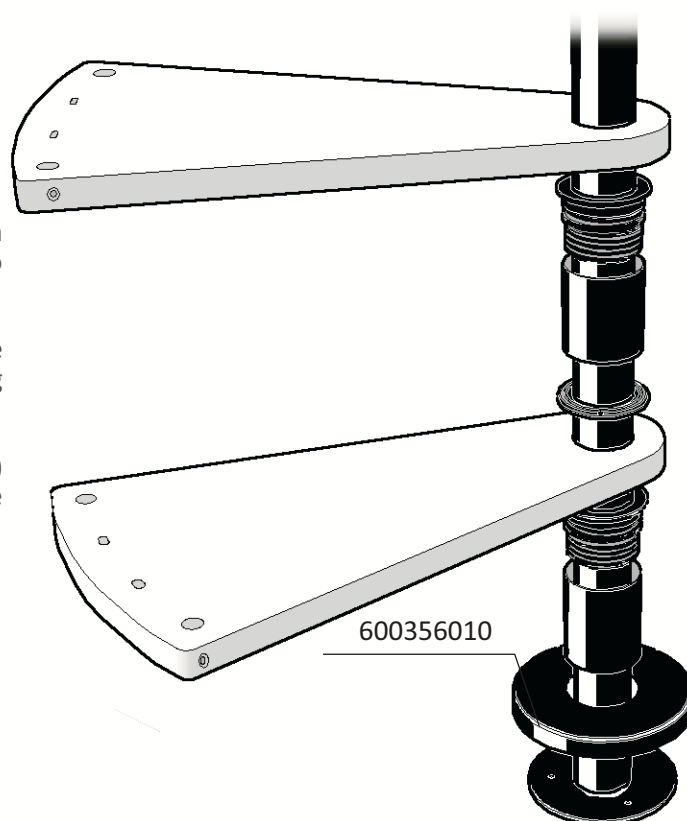

Gamia Wood

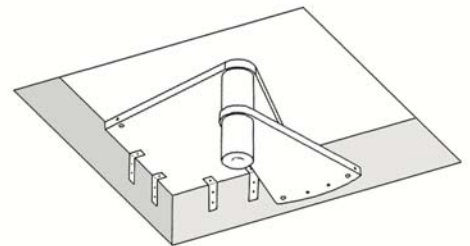
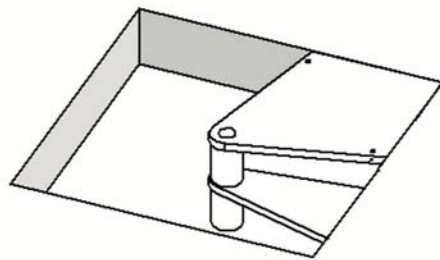
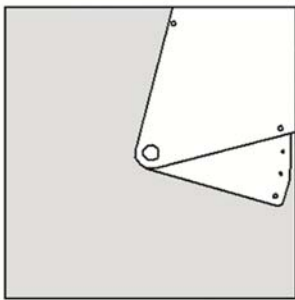
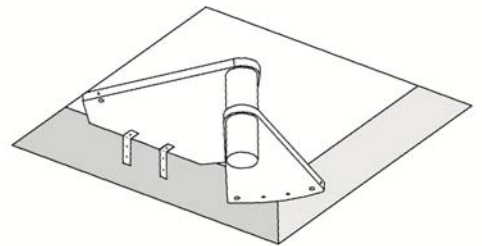
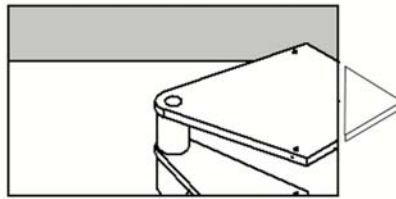
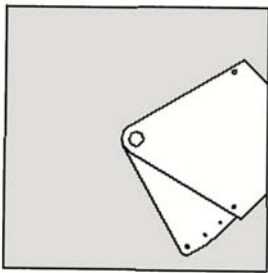
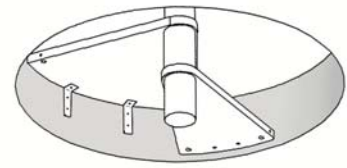
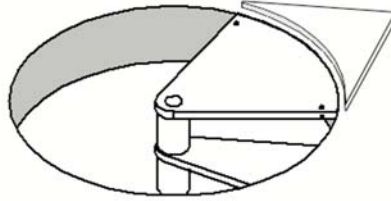
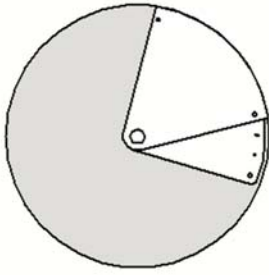

5 Fissare pianerottolo di arrivo. / Position the landing. / Positionner la marche d'arrivée. / Fijar el rellano de desembarque. / Das Podest befestigen.

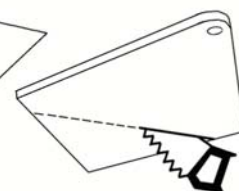
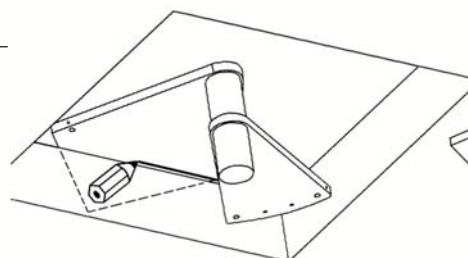
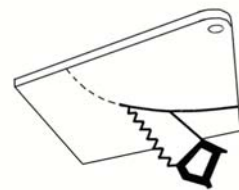
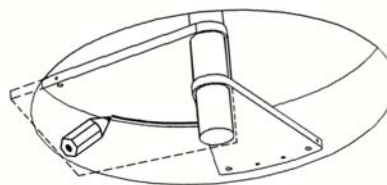
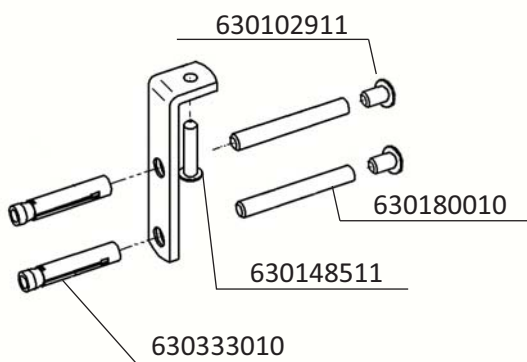

Gamia Wood

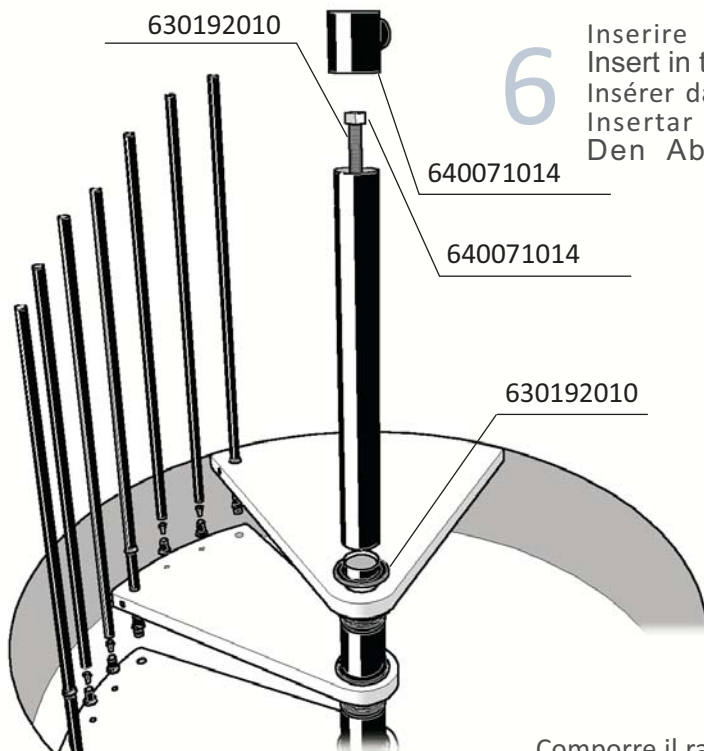

6

Inserire nel palo la flangia terminale.
Insert in the post the upper post washer.
Insérer dans le poteau le bride terminal.
Insertar en el eje la brida terminal.
Den Abschlussflansch einsetzen.

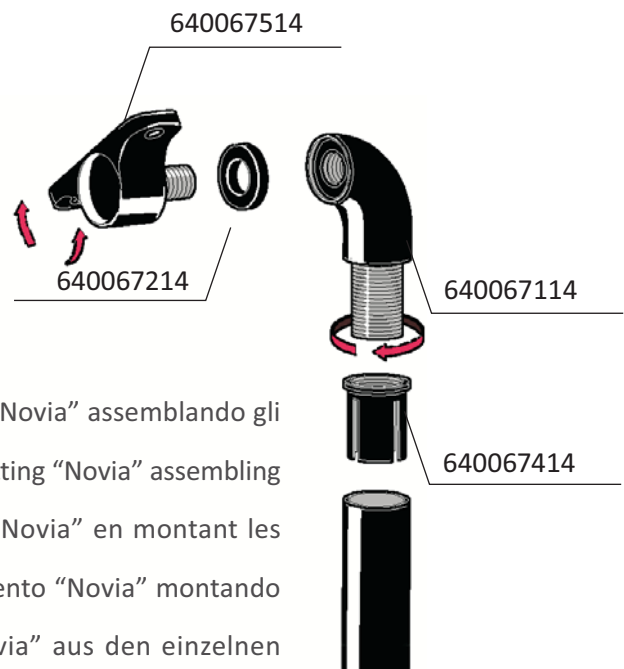

7

Comporre il raccordo "Novia" assemblando gli elementi.
Put together the pipe fitting "Novia" assembling the elements.
Assembler le raccord "Novia" en montant les éléments.
Componer el acoplamiento "Novia" montando los elementos.
Das Anschließstück "Novia" aus den einzelnen Elementen zusammenbauen.

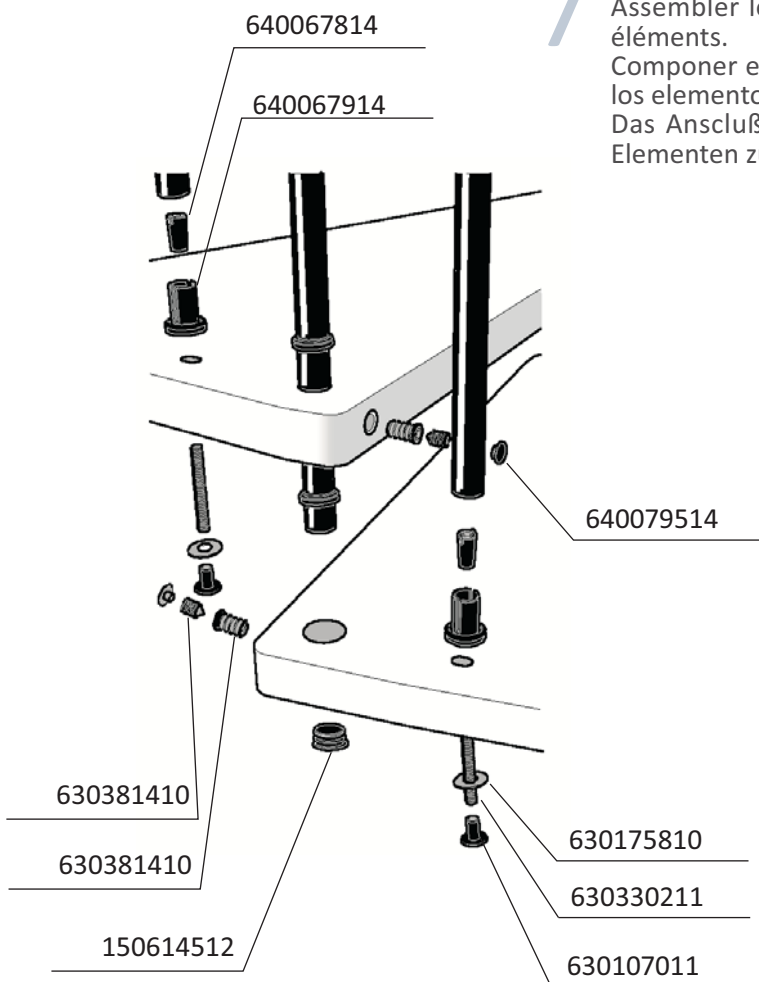

8

Inserire le colonne in tutti i gradini, bloccando quelle passanti con i grani e quelle sul gradino con la boccola ad espansione "Espa".

Insert balusters in all steps, doweling the ones that go through the step and locking the other ones with the expansion bushing "Espa".

Insérer les balustres dans toutes les marches en bloquant ceux du type passant avec les vis et ceux sur la marche avec l'expansion "Espa".

Insertar los barrotes en todos los peldaños, bloqueando aquellos pasantes con los tornillos sin cabeza y aquellos sobre el peldaño con el casquillo de expansión "Espa".

Die durchführenden Stäbe müssen durch die Stifte befestigt werden. Die andere Stäbe in allen Stufen mit den Expansions buchsen „Espa“ einsetzen.

Gamia Wood

La prima colonna della scala va tagliata e fissata a terra tramite il "Bicchierino".

The first baluster of the stair need to be cut and secured to the floor with pipe fitting „Bicchierino”.

9 Découper et fixer au sol le premier balustre avec le gobelet "Bicchierino".

El primer barrote de la escalera se corta y se fija en el suelo mediante la taza "Bicchierino".

Das erste Stab der Treppe wird geschnitten und mit dem "Bicchierino" befestigt.

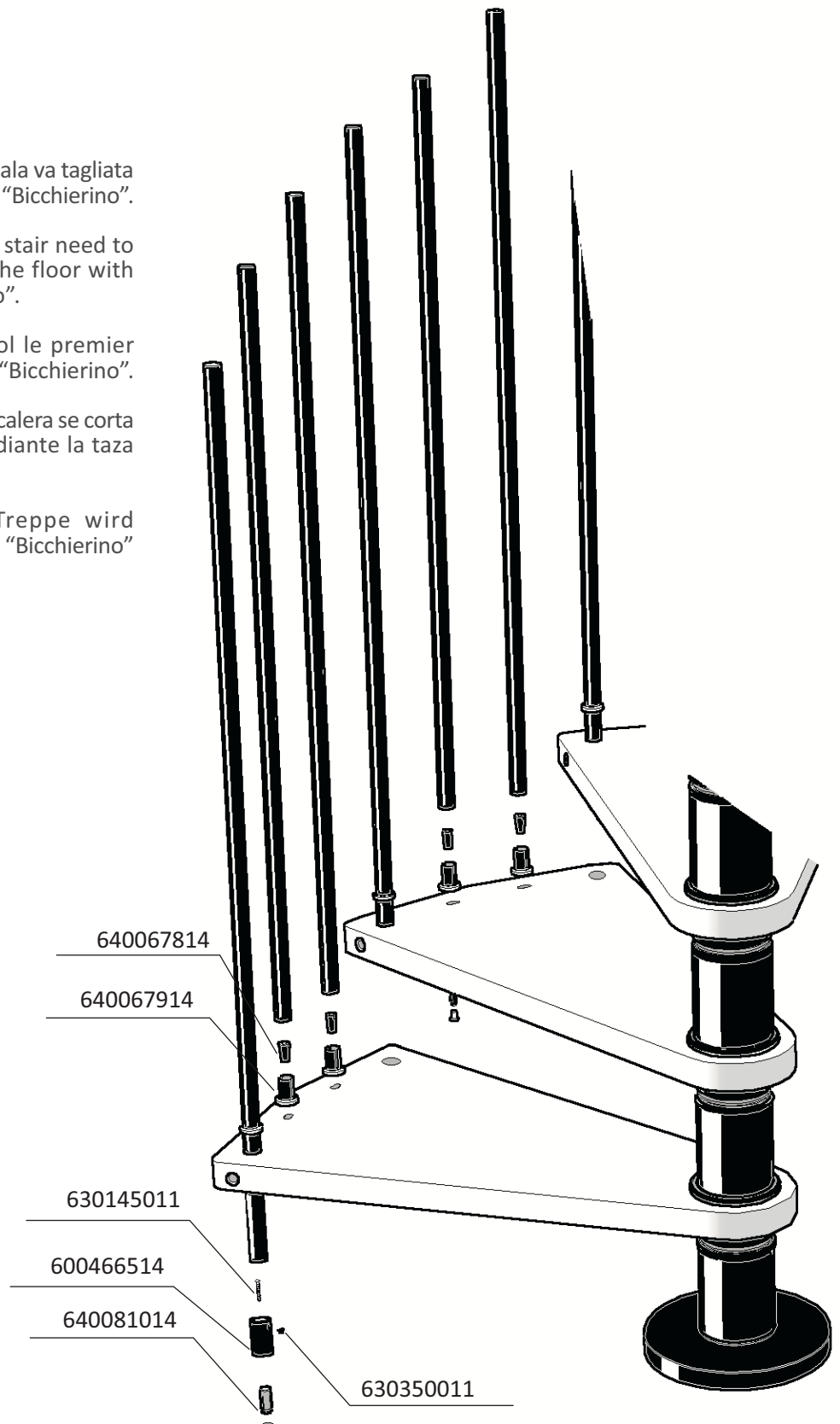

Gamia Wood

10

Regolazione colonne

Prima di bloccare le colonne eseguire la regolazione della pendenza in funzione dell'alzata.

Balusters ajustement

Before baluster's tightening it is necessary to adjust the slope according to the risers.

Réglage des balustres

Avant de bloquer les balustres, régler les en fonction de la pente créée par la hauteur de marche.

Regulación de los barrotes

Antes de bloquear los barrotes, hay que regular la pendencia en función de la contrahuella.

Einstellung der Stäbe

Vor der Befestigung der Stäbe muß die Steigung in Abhängigkeit von der Stufenhöhe eingestellt werden.

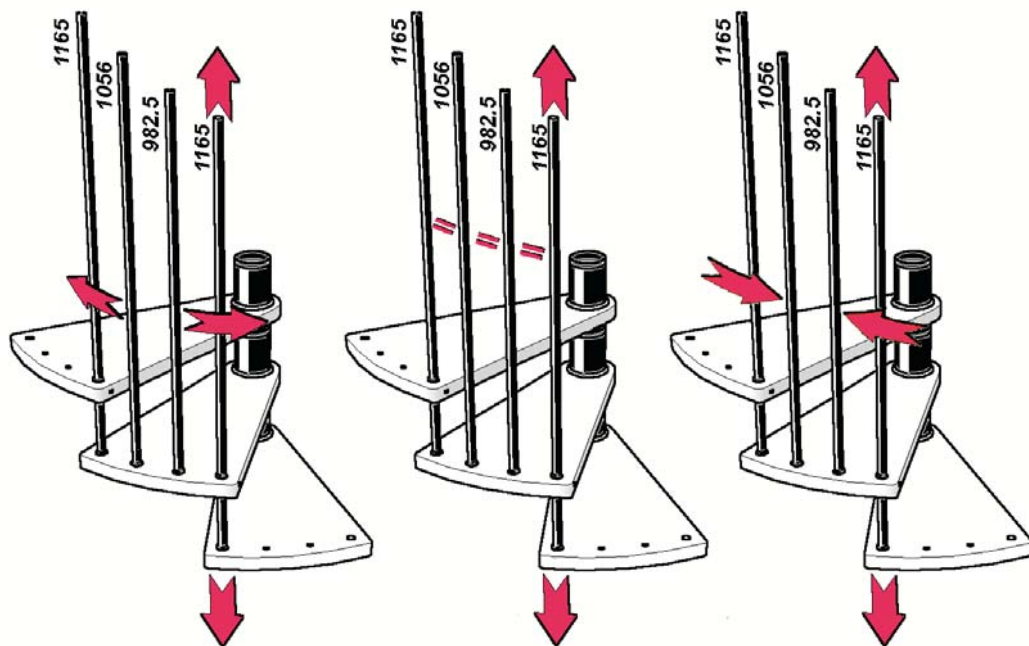

Ø scala / stair/ escalier / escalera/ treppe
120 – 140 mm; (47 1/4" - 55 1/8");

Ø scala / stair/ escalier / escalera/ treppe
160 mm (63")

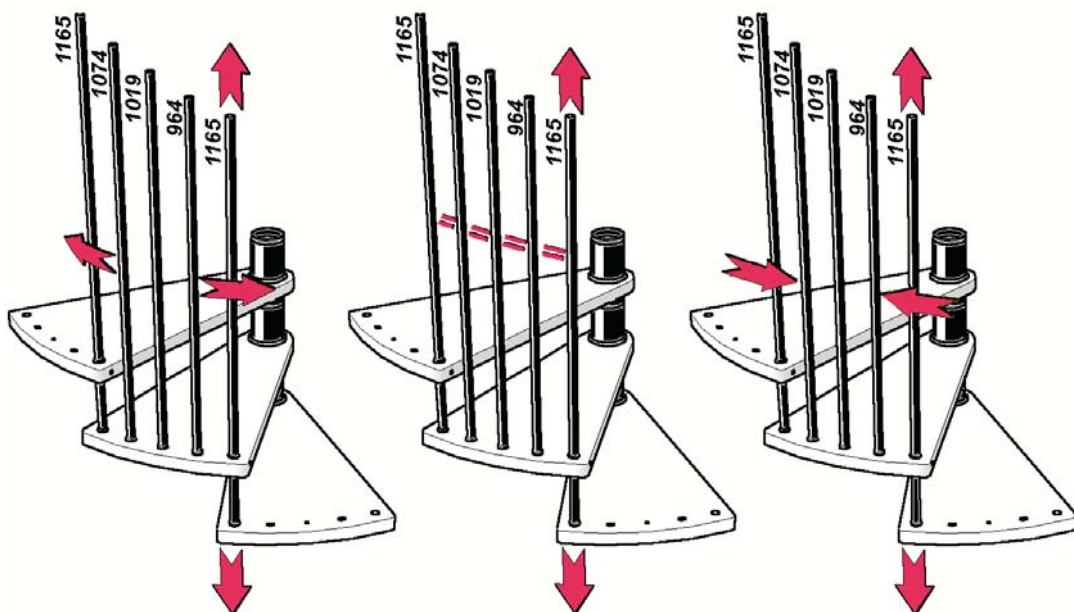

Gamia Wood

11



Questo disegno mostra il kit "traversino / alzata" montato sul mod. GAMIA LEGNO. Per la scala GAMIA METALLO le istruzioni di montaggio sono le medesime.

This draw shows the assembling of "Safety-riser" for model Gamia Wood. The same instructions are for model Gamia Metal.

Ce dessin montre le kit bras / hauteur de marche assemblé sur le modèle GAMIA BOIS. Pour l'escalier GAMIA METAL les instructions de montage sont les mêmes.

Este diseño muestra el kit barra/contrahuella montado sobre el modelo GAMIA MADERA. Para la escalera GAMIA METAL las instrucciones de montaje son las mismas.

Die Zeichnung betrifft die Kit "Sicherheit der Steigung" für das Modell Gamia Holz Was die Gamia Metall betrifft so ist die Montageanleitung die gleiche.

Gamia Wood

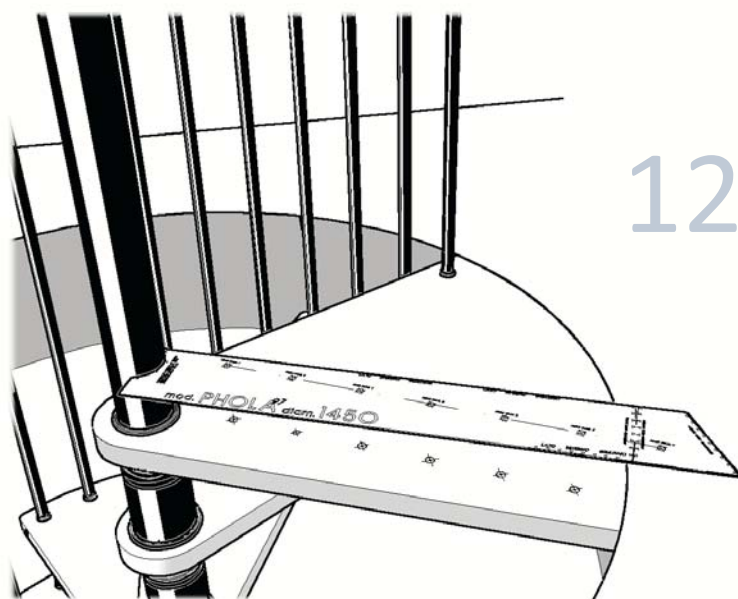

12

Montaggio balaustrino del gradino di arrivo
Forare il gradino di arrivo con punta \varnothing 10 mm utilizzando la sagoma di cartone in dotazione.

Montage de la rampe du palier d'arrivée
Percer la marche d'arrivée avec un foret \varnothing 10 mm en utilisant le gabarit en carton fourni.

Montaje de la barandilla del rellano de desembarque
Perforar el rellano de desembarque con una punta \varnothing 10 mm utilizando la plantilla que viene en el paquete.

Assembling of landing balustrade
Drill holes in the landing step with a \varnothing 10 mm (3/8") bit, using the issued paper template.

Montage des Geländerpodest
Die Austrittstufe mit einem Bohrer \varnothing 10 mm bohren und dabei die migelieferte Schablone verwenden.

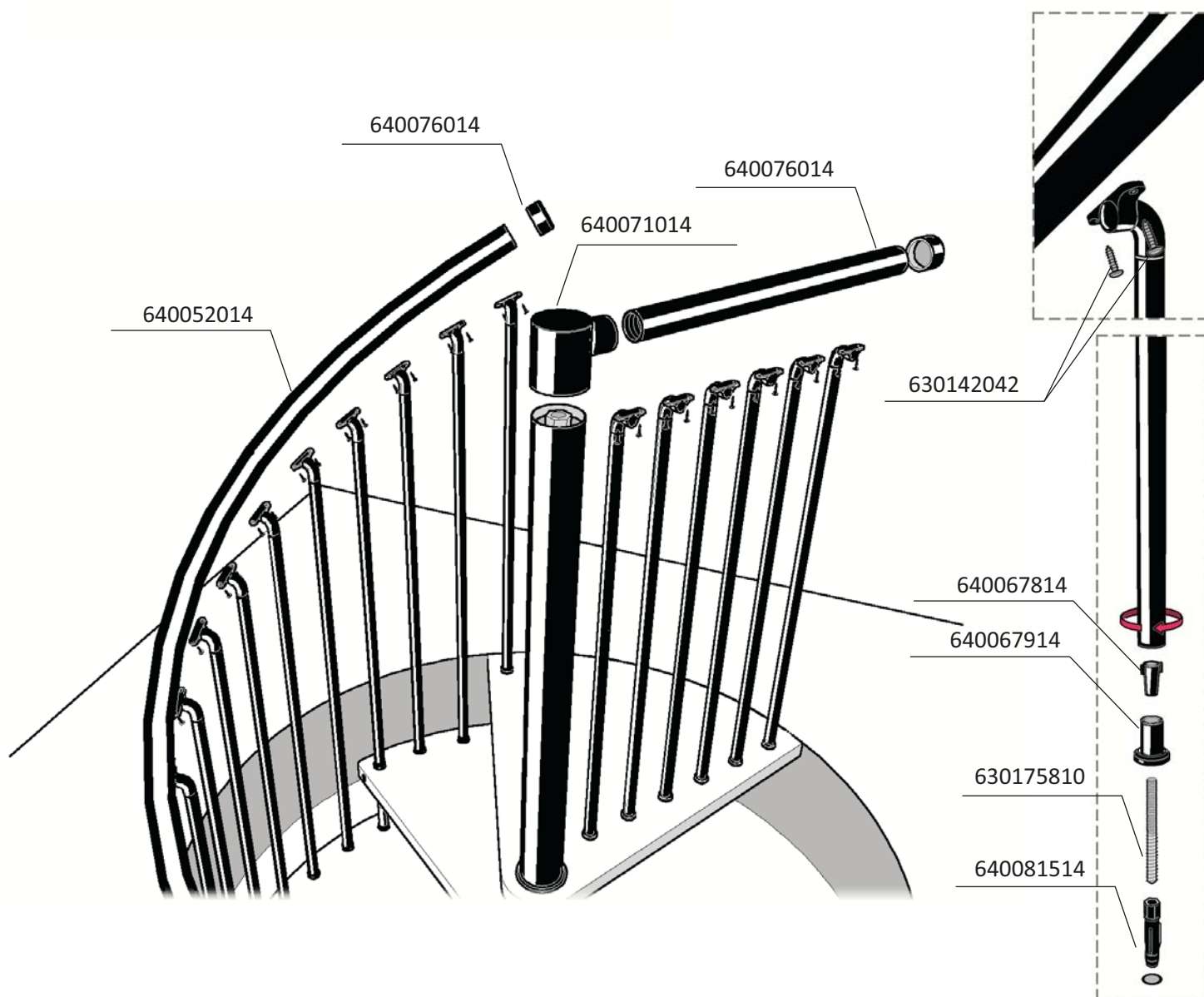

Gamia Wood

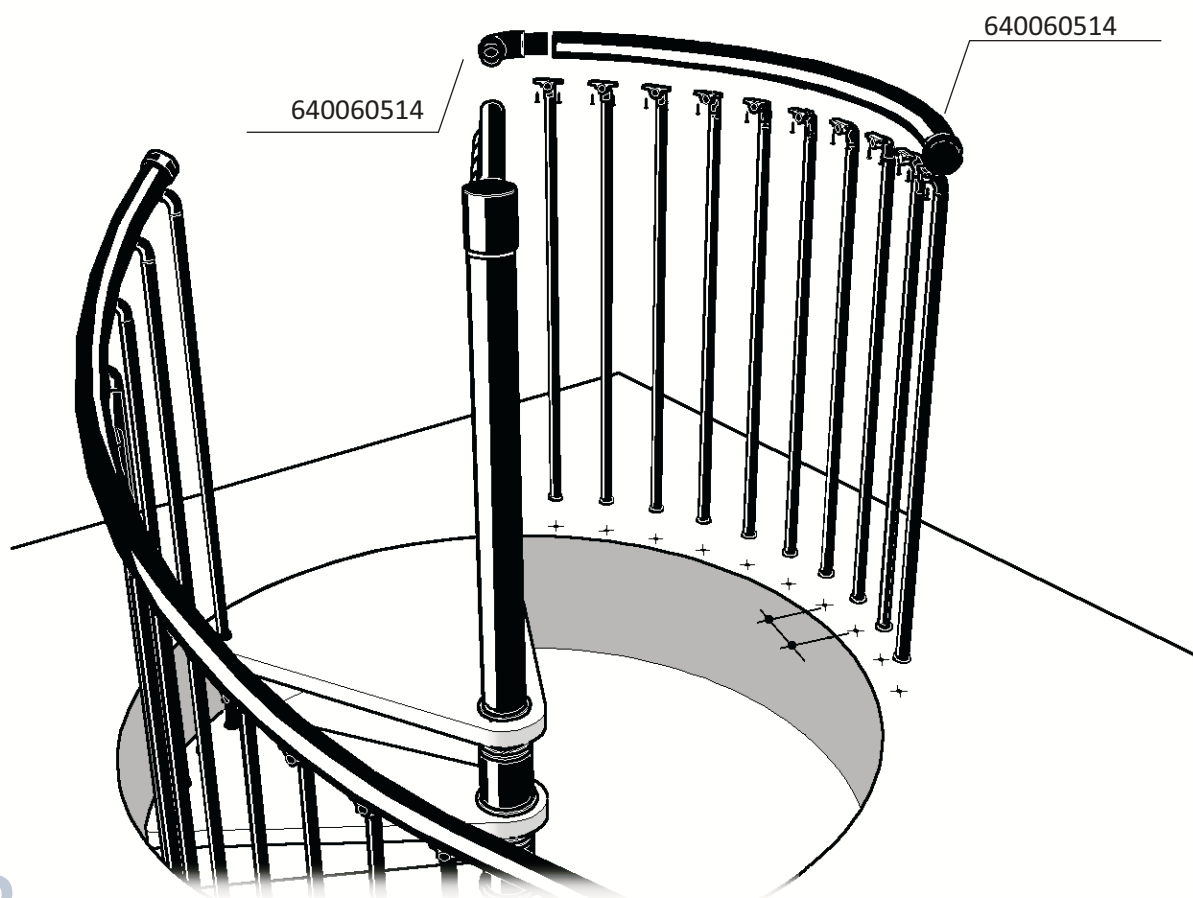

13

Montaggio Balastra

-Assemblare le colonne (ht. 925 mm) inserendo la boccia "Espa" ed avvitando il mordente. -Tracciare sul pavimento il centro delle colonne mantenendo la distanza dal foro di circa 50 mm (L'interasse tra le colonne non deve superare i 120 mm). - Forare con punta \varnothing 12 mm ed inserire gli espansori in nylon.

Balusters assembling

- Assemble the balusters (Ht. 925 mm, 36 3/8") connecting the bushing "Espa" and screwing the fitting. - Mark out the floor the central position of the balusters for the balustrade, note also that a distance of about 50 mm (2") from the opening is needed and that the axle base among the balusters can't be over 120 mm (4 1/2"). - Drill holes with a \varnothing 12 mm (1/2"94) bit and insert the nylon expanders.

Montage du garde-corps









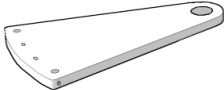
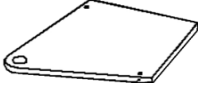
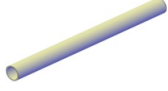
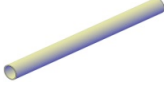
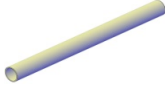
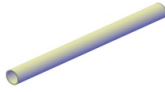

-Assembler les balustres du garde-corps (h. 925 mm) en insérant la pièce "Espa" et en serrant le mordant. -Tracer au sol l'axe des balustres du garde corps en gardant une distance par rapport au bord de la trémie d'environ 50 mm (L'entraxe entre les balustres ne doit pas excéder les 120 mm). - Percer avec un foret \varnothing 12 mm et insérer les chevilles à expansion en nylon.

















Montaje balastra

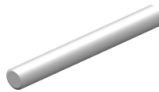











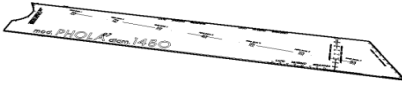

-Montar los barrotes (ht. tot. 925 mm) metiendo el casquillo de expansión "Espa" y atornillando el mordente. -Señalar sobre el suelo el centro de los barrotes manteniendo la distancia desde el orificio de alrededor de 50 mm (la distancia entre los agujeros de los barrotes no tiene que superar los 120 mm). - Perforar con una punta \varnothing 12 mm e introducir los expansores de nylon.

Montage der Balustrade

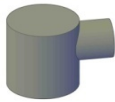

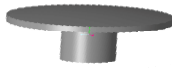





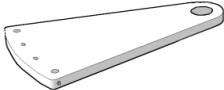
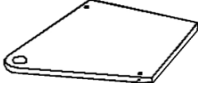
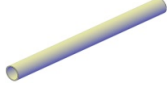
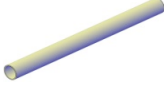
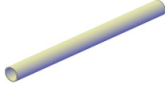
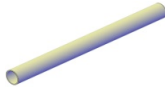

- Die Stäbe der Balustrade (H 925 mm) zusammenbauen, in dem die „Espa“ - Buchsen eingesetzt werden; dann die selbstschneidende Schraube anziehen, bis sie greift - Auf dem Boden die Mitte der Stäbe für die Balustrade anzeichnen und dabei berücksichtigen, dass ein Abstand von der Öffnung von ca.50 mm eingehalten werden muss und dass der Abstand zwischen der Stäben nicht mehr als 120 mm betragen darf. - Dann die Löcher mit einem Bohrer \varnothing 12 mm bohren und die Expansionselemente aus Nylon einsetzen: an diesem Punkt die Stäbe anschrauben und den Handlauf befestigen.

















Ø 1200	KIT 12+1	COD.	IMAGE
	12	111402012	
	1	111410012	
	5	600230514	
	11	600231714	
	11	600232514	
	14	600233014	
	4	600472014	
	13	600411014	
	1	600347014	
	1	600356114	
	2	600490000	
	1	600496002	
	1	600497002	
	1	600498002	
	1	600340114	

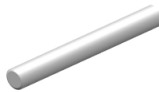













Ø 1200	KIT 12+1	COD.	IMAGE
	1	600467514	
	2	600466514	
	1	630103510	
	6	630102710	
	90	630142011	
	4	630148511	
	2	630145011	
	32	630175810	
	8	630180010	
	13	150614512	
	26	630353511	
	3	630133511	
	1	630192000	
	5	630350011	
	11	630333010	
	32	630107011	

Ø 1200	KIT 12+1	COD.	IMAGE
	8	630102911	
	26	630381410	
	32	630330211	
	1	650191000	
	1	9964520	
	45	640067114	
	45	640067214	
	45	640067414	
	45	640067514	
	1	640071014	
	3	640076014	
	26	640079514	
	1	650800000	
	13	640058014	
	13	640044014	
	13	640045014	

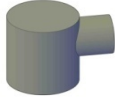

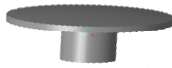





Ø 1200	KIT 12+1	COD.	IMAGE
	32	640067814	
	32	640067914	
	2	640081014	
	38	640060014	

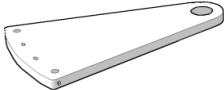
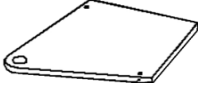
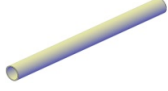
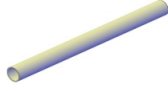
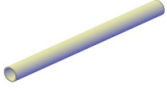
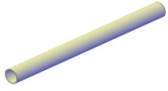
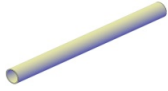















Ø 1400	KIT 12+1	COD.	IMAGE
	12	111404012	
	1	111410512	
	7	600230514	
	11	600231714	
	11	600232514	
	14	600233014	
	4	600472014	
	13	600411014	
	1	600347014	
	1	600356114	
	2	600490000	
	1	600496002	
	1	600497002	
	1	600498002	
	1	600340114	

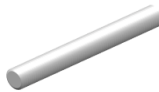











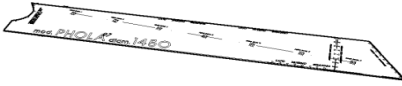

Ø 1400	KIT 12+1	COD.	IMAGE
	1	600467514	
	2	600466514	
	1	630103510	
	6	630102710	
	90	630142011	
	4	630148511	
	2	630145011	
	32	630175810	
	8	630180010	
	13	150614512	
	26	630353511	
	3	630133511	
	1	630192000	
	5	630350011	
	11	630333010	
	32	630107011	

Ø 1400	KIT 12+1	COD.	IMAGE
	8	630102911	
	26	630381410	
	32	630330211	
	1	650193000	
	1	9964520	
	45	640067114	
	45	640067214	
	45	640067414	
	45	640067514	
	1	640071014	
	3	640076014	
	26	640079514	
	1	650800000	
	13	640058014	
	13	640044014	
	13	640045014	

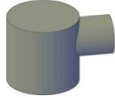
Ø 1400	KIT 12+1	COD.	IMAGE
	32	640067814	
	32	640067914	
	2	640081014	
	38	640060014	

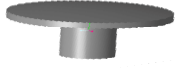
Ø 1600	Q. KIT 12+1	COD.	IMAGE
	12	111406012	
	1	111410812	
	7	600230514	
	12	600231514	
	12	600232114	
	12	600232714	
	14	600233014	
	4	600472014	
	13	600411014	
	1	600347014	
	1	600356114	
	2	600490000	
	1	600496002	
	1	600497002	
	1	600498002	
	1	600340114	

Ø 1600	Q. KIT 12+1	COD.	IMAGE
	2	600467514	
	3	600466514	
	1	630103510	
	6	630102710	
	114	630142011	
	4	630148511	
	3	630145011	
	44	630175810	
	8	630180010	
	13	150614512	
	26	630353511	
	3	630133511	
	1	630192000	
	6	630350011	
	11	630333010	
	44	630107011	

Ø 1600	Q. KIT 12+1	COD.	IMAGE
	8	630102911	
	26	630381410	
	44	630330211	
	1	650195000	
	1	9964525	
	57	640067114	
	57	640067214	
	57	640067414	
	57	640067514	
	1	640071014	
	3	640076014	
	26	640079514	
	1	650800000	
	13	640058014	
	13	640044014	
	13	640045014	

Ø 1600	Q. KIT 12+1	COD.	IMAGE
	44	640067814	
	44	640067914	
	3	640081014	
	38	640060014	